

**ARMCHAIR**

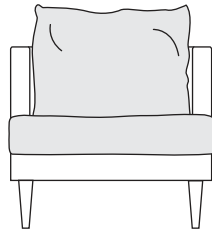

strona/page/Seite 1-2

**F1** x2

no 154A

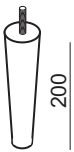

**G1** x2

no 154B

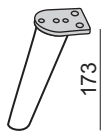

WSI M6x25

**A** x4



L-4

**C** x1



φ45x3

**D** x2



φ20x2

**E** x4

strona/page/Seite 2

**H1** x2

no 150B

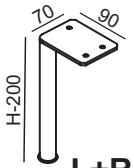

**L+R**

**I1** x2

no 150C

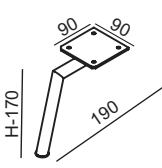

WS M6x25

**K** x14



φ20x2

**M** x4

**1**

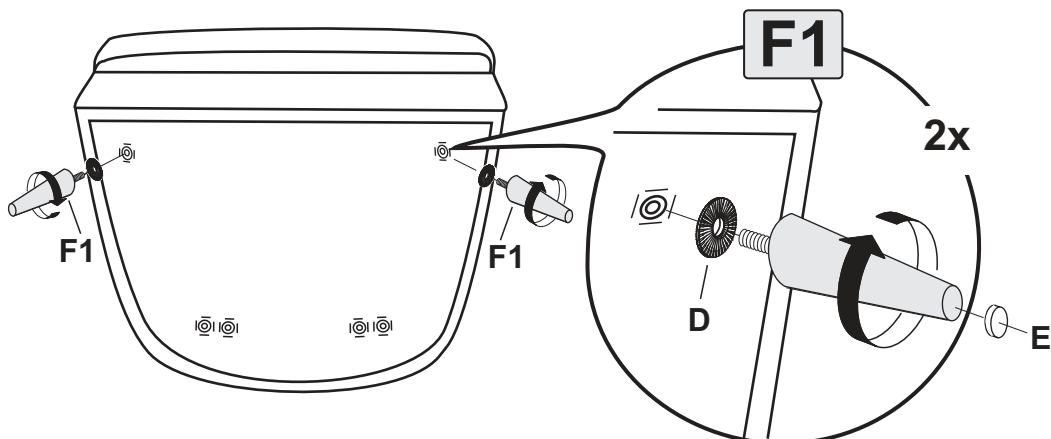

2

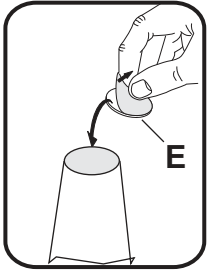
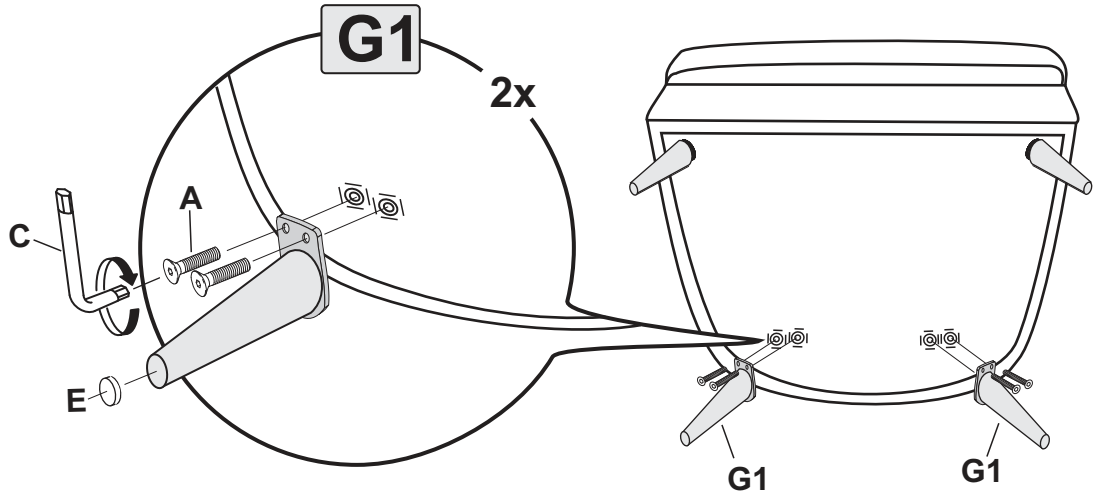

3

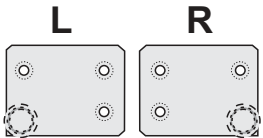
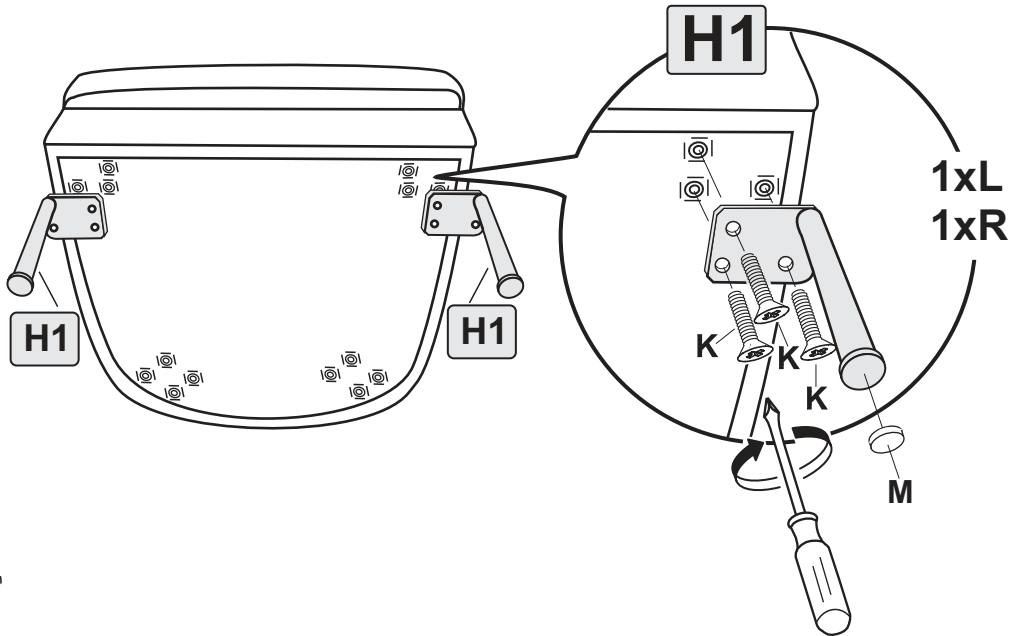

4

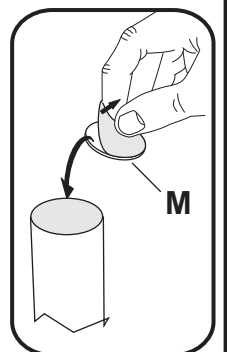
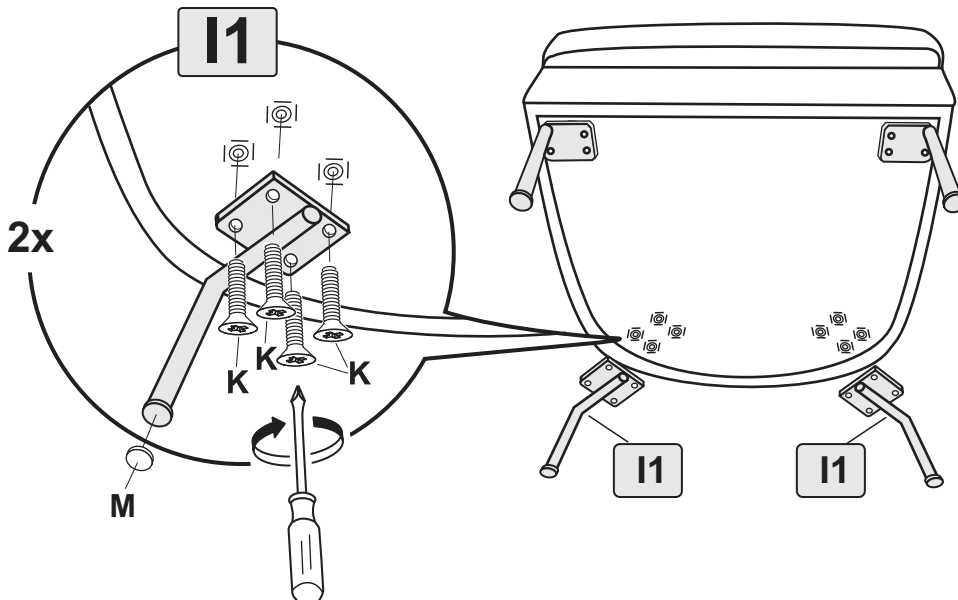

2

## FOOTSTOOLS

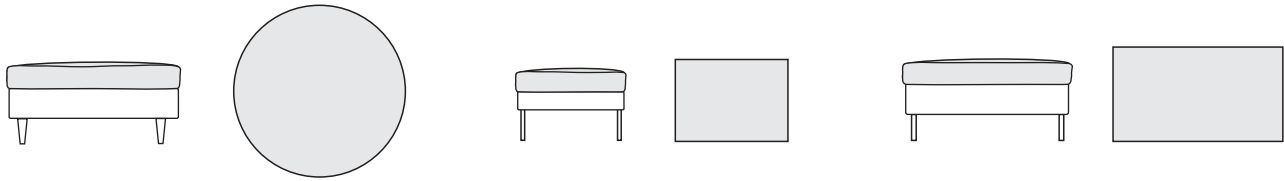

strona/page/seite 4

**A1** x4

no 153

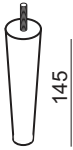

$\phi 45 \times 3$

**D** x4



$\phi 30 \times 2$

**E** x4

strona/page/seite 4

**J1** x4

no 150D

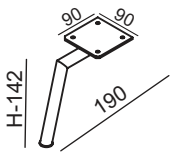

WS M6x25

**K** x16



$\phi 20 \times 2$

**M** x4

strona/page/seite 5

**F1** x4

no 154A

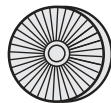

$\phi 45 \times 3$

**D** x4



$\phi 20 \times 2$

**M** x4

strona/page/seite 5

**K1** x4

No 149

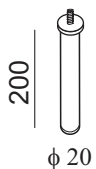

$\phi 20$

5

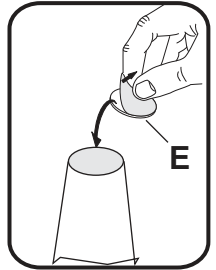
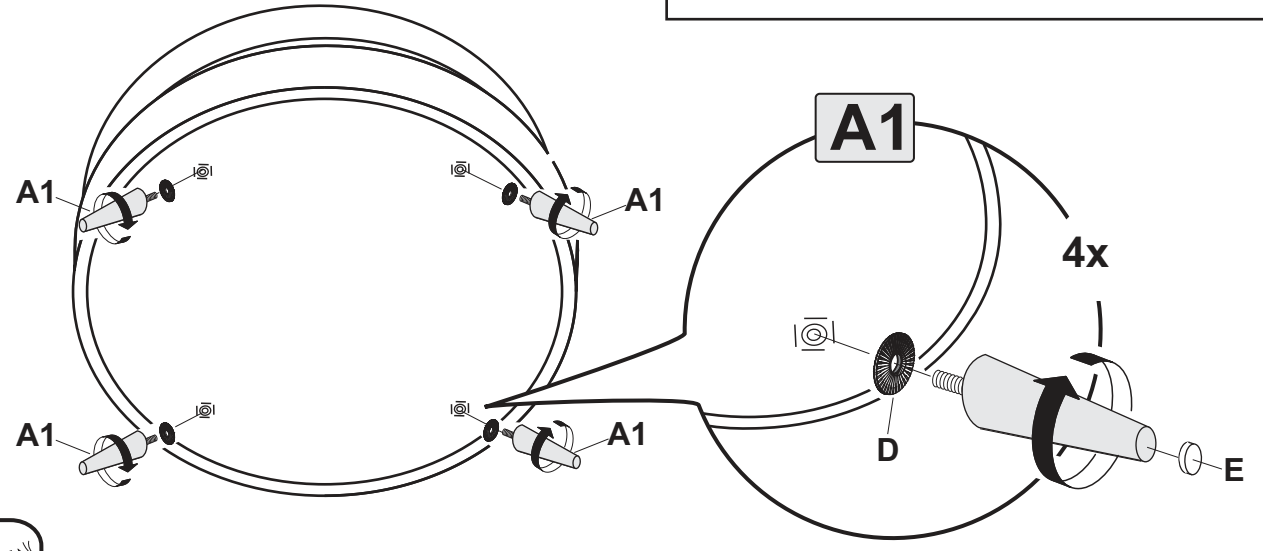
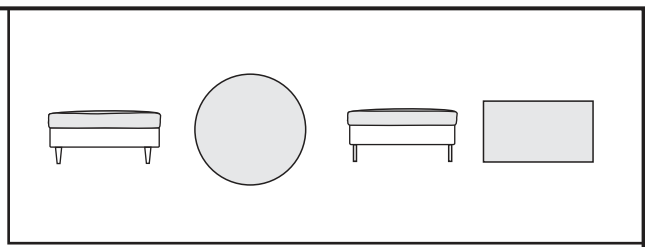

6

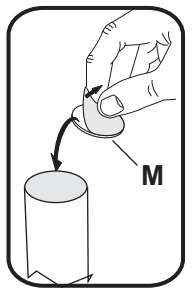
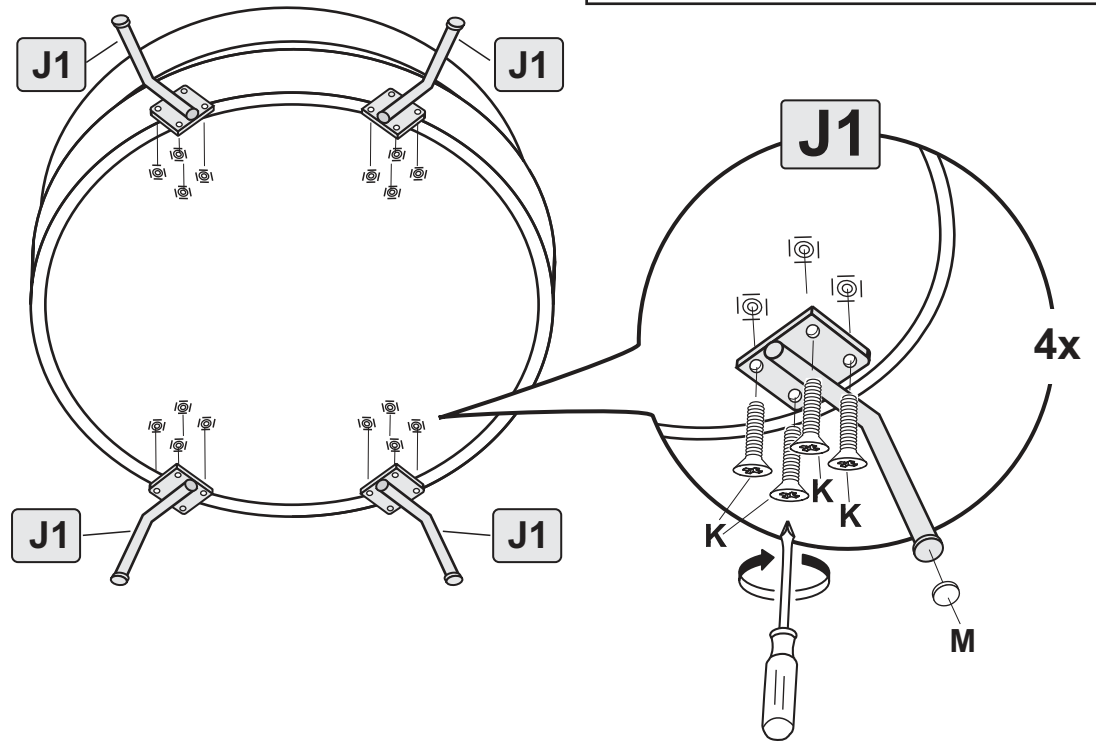
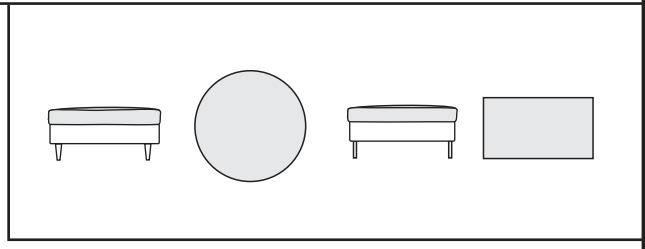

4

7

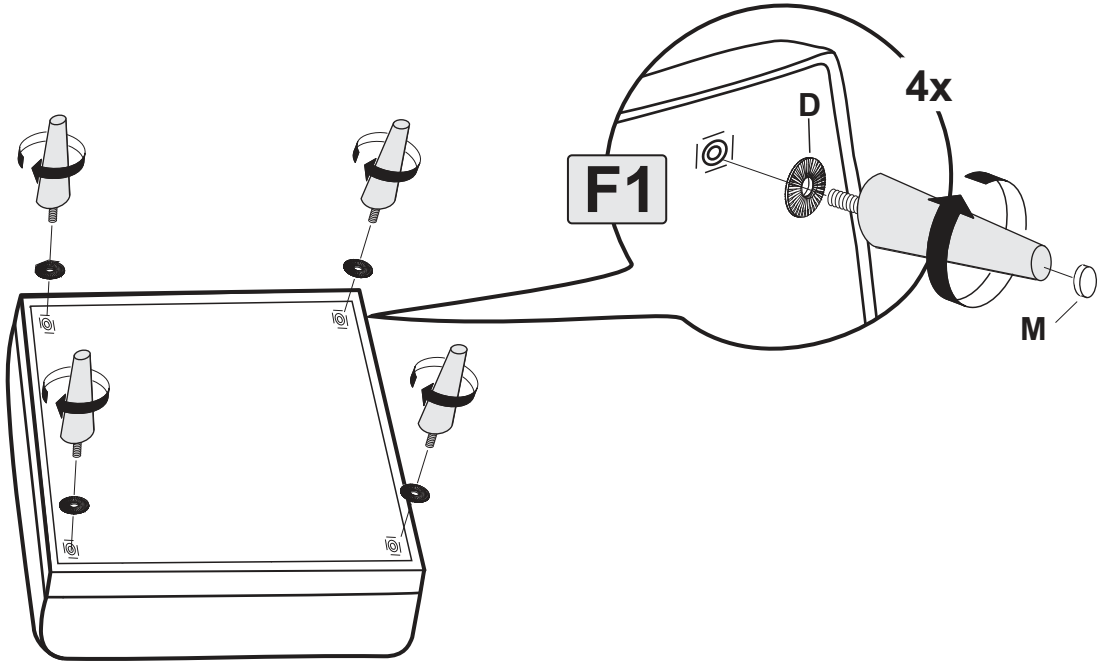
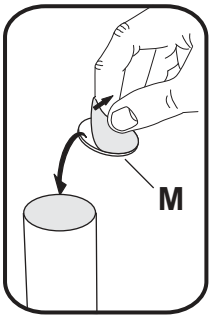

8

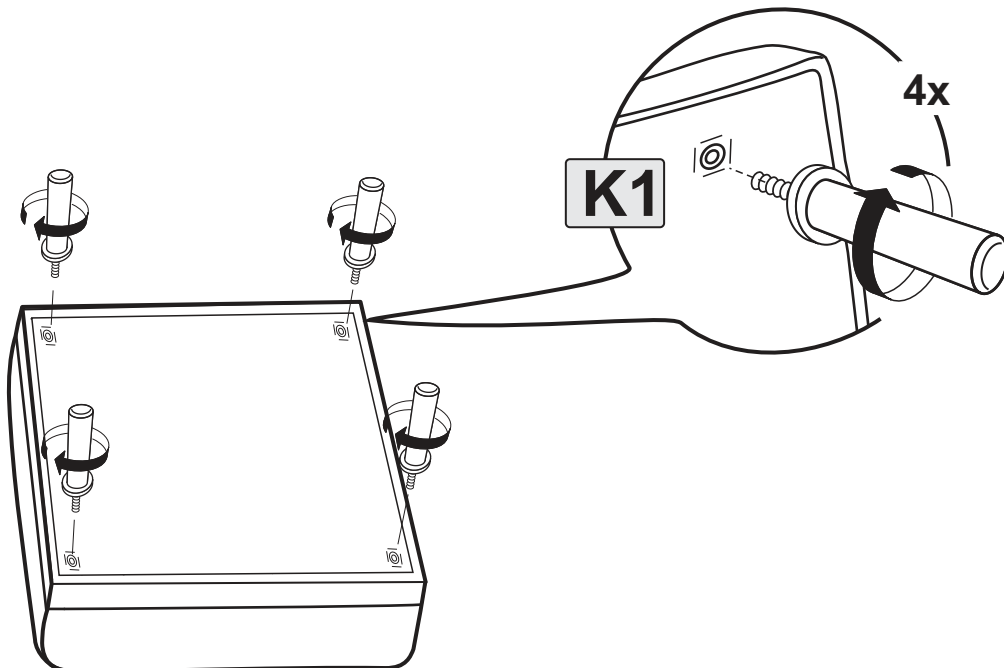
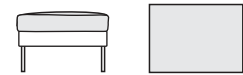

9

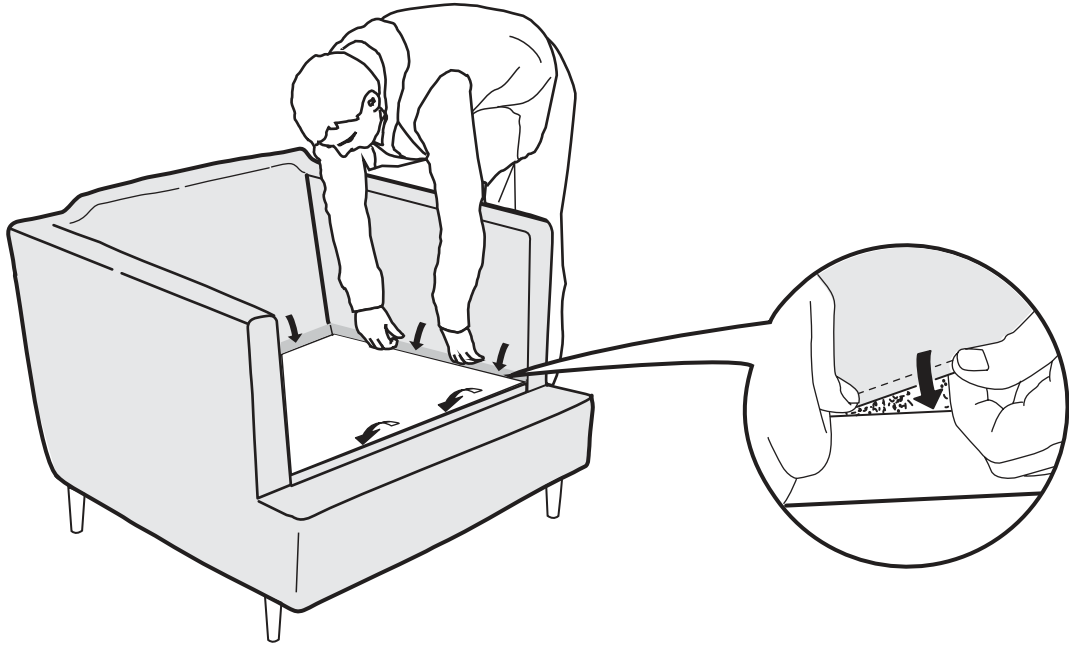

10

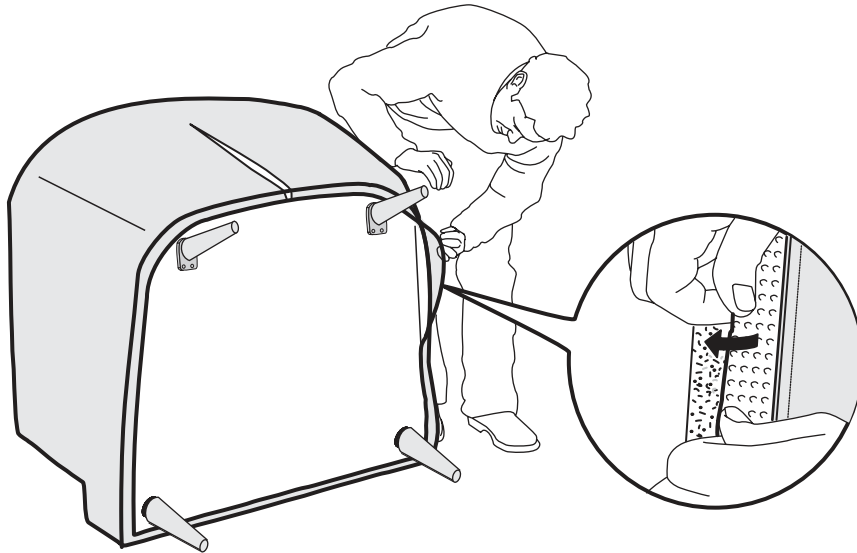

11

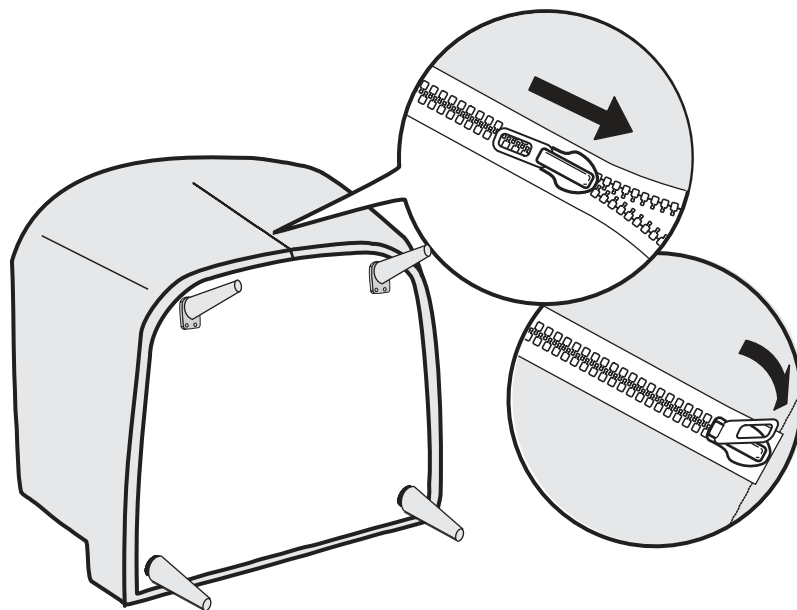

Zachowaj instrukcję / Please keep instructions / Bewahren Sie die Anleitung / Merci de garder l'instruction